



**DRIVEN BY POSSIBILITY™**

BROCHURE NO.	50167
EDITION	2024
SUPERSEDES	50167 (2020)

# INDUSTRIAL FLUID POWER

HYDRAULIC TUBE FITTINGS OVERVIEW





DRIVEN BY POSSIBILITY™

# UNPARALLELED PERFORMANCE – IN MANUFACTURING, QUALITY, SUPPLY AND SUPPORT

## FLUID POWER

- 1 Luxembourg: European Headquarters
- 2 Erembodegem: Administrative Centre
- 3 Euskirchen: Technical Center
- 4 Ghent: Distribution Centre
- 5 Karvina: Coupling Manufacturing
- 5 Karvina: Manipulated Tube Manufacturing
- 6 Legnica: Hose Manufacturing
- 6 Legnica: Hose Assembly Manufacturing
- 7 St Neots: Hose Assembly Manufacturing
- 7 St Neots: Technical Center
- 8 Izmir: Tube Fitting Manufacturing





**EVERY DAY, DESIGN ENGINEERS, MAINTENANCE PEOPLE, EQUIPMENT MANUFACTURERS AND THEIR CUSTOMERS AROUND THE WORLD RELY ON GATES AND OUR HIGH QUALITY LINE OF HYDRAULIC PRODUCTS TO MEET THEIR FLUID POWER NEEDS AND TO KEEP THEIR MACHINES RUNNING SMOOTHLY, SAFELY AND RELIABLY. THANKS TO THE GATES INTEGRATED SYSTEM APPROACH, ALL YOUR FLUID POWER PRODUCTS WORK TOGETHER SEAMLESSLY.**

From our global leadership position in hose assemblies, we have expanded our capabilities into tubing technology and complete port-to-port hydraulics:

- Rigid Tube Assemblies
- Robotic Tube Bending & Welding
- Integrated hose/tube combinations
- Tube Fittings, End Forming & Adaptors
- VEVA (Value Engineering Value Analysis) & Services

Wherever you are, the state-of-the-art technology in our production locations and assembly centres allow us to support OEM's around the world with customised just-in-time solutions to meet their tight schedules, volumes and high expectations. We also offer replacement market customers the right equipment to manufacture factory-quality product assembly on their own premises and be the nearby go-to distributor with the right solution to every breakdown.

All Gates tube line, tube fittings, hose and adaptor products are designed and manufactured to provide innovative, reliable port-to-port solutions in an almost endless range of heavy equipment applications.

But we do not stop there. Based on our wide experience in hydraulics, hose development and leak-free hose/coupling interfaces, we have been expanding our product and market knowledge in other applications and systems over the last decades and we can now offer you Gates premium performance in industrial hoses, engine hoses and harsh roughneck oilfield applications alike.

The Gates service attitude is all about you: we help you keep costs down, make things easy to use, avoid downtime and loss of production, speed up installation, maintenance and repair - that's why people choose Gates.

# **SELF-ASSEMBLY** **THE GATES** **WAY SAVES** **YOU TIME** **AND EFFORT**

**Only a team where everyone plays their part and works together seamlessly can get a complex job done. Our hose and coupling components work together in just the same way, making it extremely simple to create high-quality hydraulic hose assemblies quickly for the equipment you're using.**

This kind of easy self-assembly is based on the Gates Integrated System approach. All our hydraulic products are specifically designed, tested and validated together to produce pre-tested and validated hose/coupling combinations that perform beyond any international standard.

This unique approach is how Gates ensures full compliance with the European Machinery Directive and the reason why Gates is known as the world's most trusted hydraulic hose assembly manufacturer. That is why Gates is your total fluid power solution.

**WITH GATES, YOU BENEFIT FROM THE STRENGTH AND EXPERTISE OF A GLOBAL MANUFACTURER, THE INNOVATIVE AND RELIABLE ASPECTS OF GERMAN ENGINEERING, AND THE CONVENIENCE OF A NEARBY DISTRIBUTION NETWORK, LOCAL PRODUCT SUPPORT AND USEFUL ONLINE TOOLS. A WINNING COMBINATION BY ANY STANDARDS.**





## THE WORLD OF TUBE FITTINGS

With patented technologies designed to perform in extreme conditions, Gates is committed to create fluid power system solutions for your specific working needs.

The “made in Germany” quality ensures maximised reliability, even in critical applications. A leak-free design, with pressure safety factor 4, guarantees a safe hydraulics environment without spills and injuries. Through continuous testing and system validation we meet and exceed performance specifications. That’s why our easy-to-handle assembly machinery leads to zero failure rates. This shows in the fact that Gates’ connecting systems have received many third party approvals.

## ENGINEERED TO EXCEED EXPECTATIONS

Gates Tube Fittings according to DIN EN ISO 8434-1 and DIN 2353 are important pressure transmission components for a wide range of industrial applications, stationary equipment and mobile machinery. They are used in agricultural, automotive, industrial and marine markets where power transmission is essential. Our products are used successfully worldwide. All these areas of application and markets are subject to special and sometimes extreme conditions where the highest demands on quality are essential. The durability of the product is decisive for the availability of productivity and thus maximizes the profitability of the capital goods.

## VIRTUAL TUBE FITTINGS SOLUTIONS

Gates Tube Fittings offers its customers the possibility to access 3D-data of their product portfolio via the internet and a smartphone app, to retrieve all important technical data. The CAD data is easily accessible via our homepage, where data can be retrieved in various multilingual formats. Our 3D-CAD download portal is a new component of our customer service and therefore free of charge.

## COMMITTED TO YOUR BUSINESS

- Minimum operating costs & maximum system up-time
- Leak-free equals environment friendly
- Reduced assembly time and costs
- Best surface protection on the market
- High Quality products
- High service levels & supply flexibility

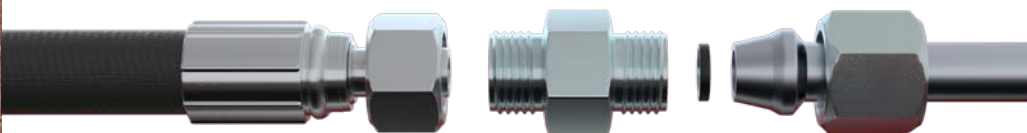

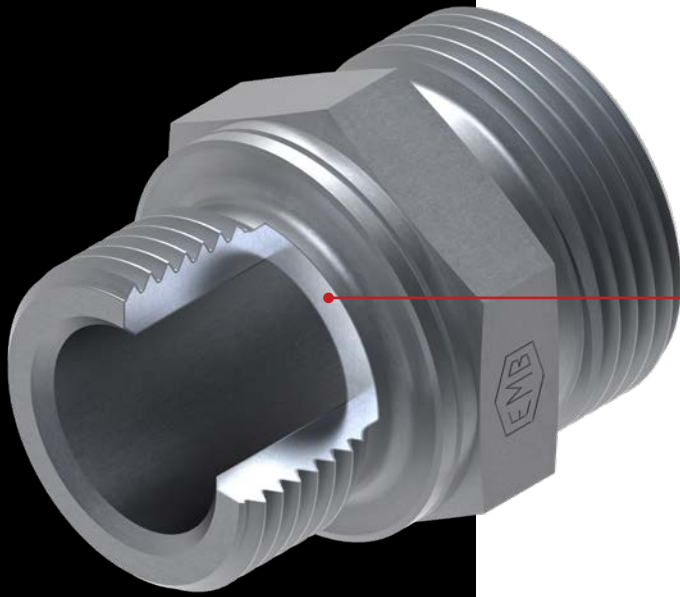

CHEMICAL SEALING

CR III PASSIVATION

ZINC NICKEL

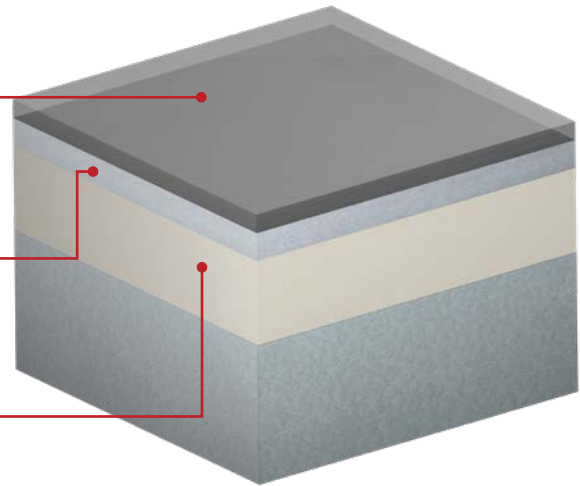

## ZINC NICKEL AS STANDARD FINISHING

- The **Zinc Nickel coating on our Gates Hydraulic Tube Fittings** protects against red rust for over 1200 hours (acc. to **ISO 9227**). It provides a significantly better surface protection than standard chrome VI free surface finishing materials, whilst easily reaching protection **class K5** of the **VDMA24576 standard**.
- The Zinc Nickel coating is compliant with the latest REACH and RoHS2 requirements, fulfilling its environmental duties.
- Zinc Nickel products can be used in a variety of applications in the Agriculture, Construction, Ship & railway, Engineering and Renewable Energy industries.
- Gates offers high quality 1.4571 grade stainless steel components on special request, for use in high temperature environments or where no corrosion is allowed: Food, Chemical, Pharmaceutical or Marine applications.
- Regardless of your requirement, Gates offers the right hydraulic tube fittings to meet your challenging applications each and every time!

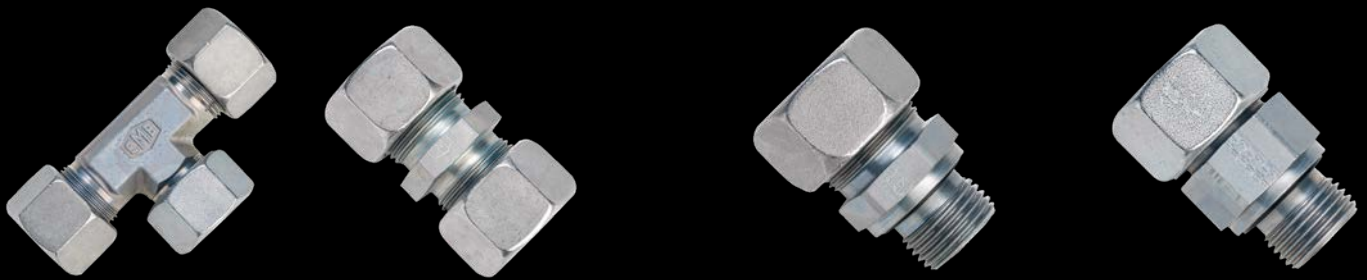

## 1. CONNECTORS

Connectors can be used to connect metric tubes, hoses and fittings to each other in whatever configuration. They are divided into 3 ranges:

- Very light series
- Light series
- Heavy series

**Designed for nominal pressures up to 800 bar (heavy series) and available in various geometries such as:**

- Straight
- Elbow (e.g. 45° and 90°)
- Tee
- Cross

## 2. MALE STUD TUBE FITTINGS

Male stud fittings allow the connection of a metric tube with a port. From metric stud end with captive seal to the imperial stud end with Form A, Gates offers a wide range of stud end fittings. Male stud tube fittings are available in (according to ISO 8434-1 / DIN 2353):

- Very light series
- Light series
- Heavy series

**Designed for nominal pressures up to 800 bar (heavy series) and available in various geometries such as:**

- Straight
- Elbow (e.g. 45° and 90°)
- Tee

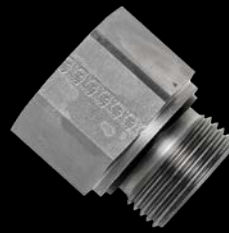

### 3. ADJUSTABLE TUBE FITTINGS

Adjustable tube fittings allow the connection of minimum one metric tube with another tube fitting or port and can be assembled in any direction. Adjustable tube fittings are available (according to ISO 8434-1 / DIN 2353) in:

- Very light series
- Light series
- Heavy series

**Designed for nominal pressures up to 800 bar (heavy series) and available in various geometries such as:**

- Elbow (e.g. 45° and 90°)
- Tee

### 4. REDUCERS AND GAUGE FITTINGS

Reducers are straight fittings and are used to reduce from one thread size to another thread size or from one metric tube size to another. Reducers thread to thread are not classified in series like connectors or male stud fittings. Reducers metric tube to metric tube (DKO) are classified (according to ISO 8434-1 / DIN 2353) in:

- Very light series
- Light series
- Heavy series

**Designed for nominal pressures up to 800 bar (heavy series).**

Gauge fittings are straight fittings, which are used to connect a gauge with another fitting, tube or hose. Available with standard 24° cone, DKO or standpipe in:

- Very light series
- Light series
- Heavy series

**Designed for nominal pressures up to 630 bar (heavy series).**



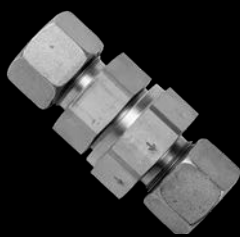

## 5. VALVES

Check valves allow the connection of metric tube to metric tube or tube to hose or to port. Non-return valves control the flow in a hydraulic system and open at a defined fixed pressure. Standard opening pressure for RD, RV and RZ is 1,0 bar. Other opening pressures are marked on the valve to allow a clear identification of opening pressure. Valves are available (according to ISO 8434-1 / DIN 2353) in:

- Light series
- Heavy series

**Designed for nominal pressures up to 400 bar (heavy series).**

ARV valves are only available in very light series with pressure ratings up to 100 bar. While RD, RV and RZ are coned valves, the ARV are ball valves. Typical applications for these valves are mainly lubrication lines.



## 6. ACCESSORIES

Accessories have a high variety, from plugs in different sealing forms and sizes to sealing rings or support sleeves. This range contains every component to complete your hydraulic fittings range.



## 7. CONTROL SYSTEM

Gates offers a wide range of test couplings, test hoses, pressure gauges and other accessories according to international standards. The extensive range allows our customers to buy tube fittings and control system from one single source.

To fulfill customer expectations, the Gates range contains different systems with M16x2, M16x1,5 or plug-in test connections.

### Benefits:

- Enables safe system pressure checks
- Leak-proof connection before cone / ball valve is open
- Simple connection with measuring, control and switching devices
- Self-locking metal guard cap

## 8. CONNECTING SYSTEMS (WELDING NIPPLES, FLARING, CUTTING RINGS, FS)

Gates provides different connecting systems that fit the standardised tube fitting range.

The cutting ring is the most common connecting system for tube fittings. Gates double edge cutting ring and double edge cutting ring with soft seal in combination with our final-assembly machine OPTICAM 4S are a strong and valuable solution for serial production.

The Gates FS system with its low degree of deformation is an excellent alternative to expensive welding nipples.

The ABO system of Gates is a soft sealed connection used instead of a JIC connection, which allows the customer to use DIN tube fittings and reduce the risk of leakages.



**ISO 8434-1 Fitting**  
DIN 2353



**Function ring with soft seal**



**Formed hydraulic pipe**  
(DIN 2391)



**Union nut**  
DIN 2353, ISO 8434-1



## THE WORLD OF ASSEMBLY MACHINERY

### EMB-FS® CONNECTION TECHNOLOGY: EASY, QUICK AND RELIABLE

The innovative 'Form & Seal' system was designed for the connection of tubes without specific tube preparation and finishing. It boasts the advantages of a welding system but the number of necessary single parts is reduced to the minimum, optimising the cost-performance ratio and minimising the system costs. The system can also be used for nearly all applications as we provide a comprehensive product portfolio of DIN 2353, ISO 8434-1 tube fittings. The EMB-FS system and assembly procedure guarantees you minimum tube stress, fast assembly and maximum retention forces.

### NO COMPROMISES, NO DIFFICULTIES

A function ring supports the final assembly. It integrates an elastomer seal into the system and protects against excessive tightening. Frictional tension between tube and fitting cone is assured with the metallic seal function. Vulcanised soft seals ensure the leak-free performance in extreme working conditions as well. Safe assembly is indicated by a clearly noticeable assembly stop.



**MORE CONTROL-MORE SAFETY-EVEN EASIER!  
THE NEW GATES EMB OPTICAM 4S**

**Our new final assembly machine OPTICAM 4S by GATES is available now.**

25 years after the OPTICAM 642, the first machine for the controlled final assembly of hydraulic tube fittings, Gates offers with the OPTICAM 4S a new generation of machine.

**Advantages**

- Optimized assembly safety due to improved hardware and software!
- Simplified operation by a new user interface panel!
- Simplified data transfer for the optimized data evaluation & analysis

OPTICAM 4S:  
*Final assembly machine*

**TUBE END FORMING & TUBE  
MANIPULATION MACHINERY**

Tube end forming is not only one of the safest methods for the connection of leak-free hydraulic tube systems but can be used as an alternative for expensive welding procedures in many cases. The result is a huge cost reduction on both labour and system assembly cost. This supports economies of scale and provides extra time and money for further projects. Operator faults are basically excluded due to automated machine functions. Gates assembly machines are developed with individual customer needs in mind like ease of use, reliability and cost performance.

FS 94:  
*Tube end forming machine*



#### CUTTING RING ASSEMBLY & FLARING MACHINERY

Today, cutting ring and flaring are still the main technologies used to connect tubes. To guarantee leak-free results, the joint procedure requires reliable machines that support the quality of the connection. Thanks to the Gates assembly machines' accurate processes, a minimum of the operator's individual intervention is required, reducing the need for manual justifications as well as process control.

*UNIPRESS 3:  
Universal machine for flaring and cutting ring pre-assembly*

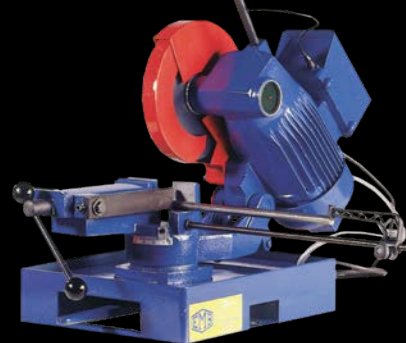

#### CUTTING MACHINES

Gates steel tube cutters are robust and compact machines, and distinguish themselves by their safe and high-quality cutting function. Our range of electrical cutters is all hand controlled for guided cutting thus allowing for optimal speed control and a reduction of blade damage. The blades are positioned close to the powerful motors to limit vibration which enhances the durability and reduces maintenance costs. But there is more: low energy consumption, CE compliant brake motors for 3-phase cutting machines, built-in protection, limited smoke production ... all supporting your safe working environment and personnel safety.

*UNICUT TC 080:  
Metal circular saw*

## **SAFETY FIRST – USE GATES TO HELP YOU**

**When working with hydraulic equipment, it's important to be aware of the potential dangers and never to underestimate the power of a hydraulic hose or tube assembly under pressure. Having the world's best hoses, couplings and fittings is not enough to ensure the safety of your hydraulic assemblies. Poor assembly, a bad installation or an incorrect method of storage can compromise performance and even safety.**

### **THE GATES SAFE HYDRAULICS PROGRAMME: THINK SAFETY!**

Your safety and that of your workforce, your customer and the environment is always a top priority for us. That's why we offer all our customers the Safe Hydraulics Programme, a safety and preventive maintenance training seminar. The programme is designed by Gates application engineers and run by experienced and certified trainers. Our seminars can be tailored to match your needs, but most include the following topics:

- How to work safely and how to reduce your risks and protect the environment
- The entire safety process: storage, selection, installation and inspection
- How to avoid material and personal hazards and liability issues
- Expert information on safety issues affecting hydraulic hose assemblies

The seminar can accommodate people from all industries, backgrounds and levels of hydraulic knowledge.

### **KEEPING YOU UP TO DATE WITH SAFETY AND LEGISLATION**

In Europe the main safety Directive covering hose and machinery products is the European Machinery Directive 2006/42/EC. This provides the regulatory basis for the harmonisation of essential health and safety requirements for machinery at European Union level. In practical terms, however, the best way to be sure you're complying with the Directive is to comply with the Harmonised European Standards. These standards are tools that help manufacturers and users comply with the Directive by giving you practical guidance on how to meet its requirements. The two most important standards on safety requirements for hydraulic hose assemblies are:

- ISO 12100:2010  
(‘Safety of machinery: Basic concepts, general principles for design’)
- ISO 4413:2010 (‘Safety of machinery – Safety requirements for fluid power systems and their components – Hydraulics’)

The good news is that the Gates Integrated System of hoses, couplings, self-assembly machines and crimp data – used together – ensure you fully comply with this European Machinery Directive.





**GATES, SAFETY IS MORE THAN  
A PRIORITY – IT'S PART OF  
EVERYTHING WE DO**



**DRIVEN BY POSSIBILITY™**

**CUSTOMER EXPERIENCE TEAM**

**VIA PHONE:**

+48718814502 FOR POLISH  
+48718814503 FOR ENGLISH  
+48718814504 FOR FRENCH  
+48718814505 FOR GERMAN  
+48718814506 FOR ITALIAN  
+48718814507 FOR SPANISH

**OR VIA E-MAIL:**

GATESCSIR@GATES.COM  
(GATES EUROPE CUSTOMER EXPERIENCE IR)

